



Pauli + Sohn GmbH



**Black**  
EDITION

# Duschen - Black Edition

Showers - Black Edition















# Inhalt

---

## Content

Duschtürband PAVONE   Shower door hinge PAVONE .....	04
Duschtürband FLAMEA+   Shower door hinge FLAMEA+ .....	14
Sauna-Pendeltürband - FLAMEA+   Sauna swing door hinge - FLAMEA+ .....	20
Duschtürband FARFALLA   Shower door hinge FARFALLA .....	24
Griffe   Door Handles .....	28
U-Profil   U-profile .....	31
Stabilisationsstangen   Supporting bars .....	32
Dichtprofile   Sealing profiles .....	36





# PAVONE

**Black  
EDITION**



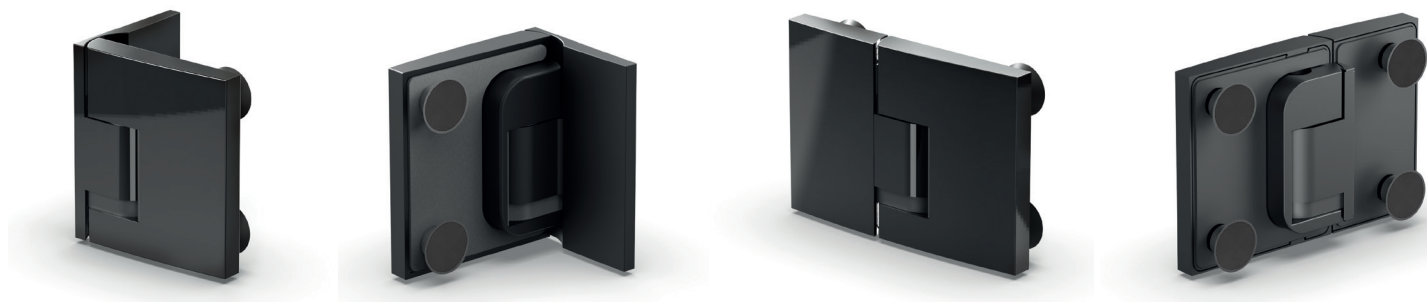

PAVONE wurde mit dem Ziel entwickelt, die positiven Eigenschaften verschiedener Duschtürbänder in einer Serie zu vereinen. Die Flächenbündigkeit für einen hohen Reinigungskomfort wird kombiniert mit den Vorzügen der Pendelfunktion. Außerdem hebt sich die Tür im Öffnungsvorgang an und senkt sich im Schließvorgang in eine stufenlos justierbare Nulllage. Diese Serie spielt Ihre Stärken bei einer barrierefreien Badplanung mit hohem Anspruch an die Ästhetik der Duschkabine aus.

- beidseitig 90° öffnendes Duschpendeltürband
- Hebe-Senkfunktion
- mit flächenbündiger Verschraubung
- im Senkvorgang selbst schließend
- stufenlose Nulllageneinstellung
- Tragfähigkeit (2 Bänder): 36 kg entsprechen einer maximalen Türflügelgröße von 900 x 2000 mm bei 8 mm Glasdicke
- optimiert für die Verbauung ohne Dichtprofil je nach baulicher Situation (3mm Luft zur Wand bei geänderter Glasbearbeitung mit Gehrungskante)
- Die Haltbarkeit der Beschläge wurde durch werksinterne Versuche nach DIN EN 14428:2015 5.5 geprüft.

PAVONE was developed with the aim of combining the positive characteristics of different shower hinges into one series. The flush design for cleaning comfort is combined with the advantages of the pendulum function. In addition, the door lifts during the opening process and descends while closing offering an infinite adjustable closing position. This series shows its advantages in barrier-free bathroom planning with high demands on aesthetics of the shower enclosure.

- 90° opening in both directions
- Lifting function
- With flush screws
- Self-Closing during the lowering process
- Infinitely variable zero adjustment
- Load capacity (2 hinges): 36 kg Corresponds to a maximum door panel size of 900 x 2000mm with 8 mm glass thickness
- Optimized for assembly without seals depending on the building situation (3mm gap to the wall with modified glass processing with mitered edge)
- The durability of the hardware were tested internally in accordance with DIN EN 14428:2015 5.5.



# Duschtürband – PAVONE

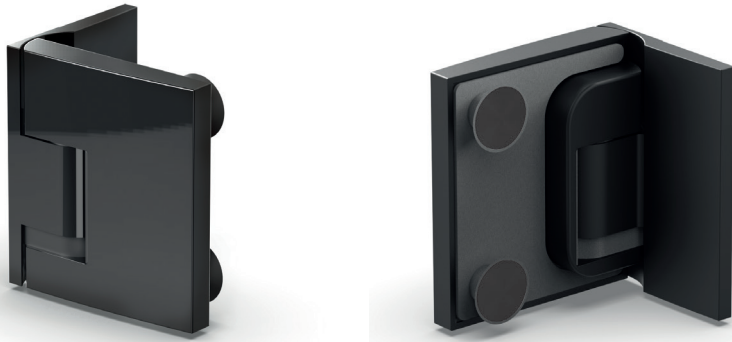

Glasbearbeitung für 8 mm  
ohne Dichtprofil  
glass processing for 8 mm without  
sealing profile



Langlochverstellung  
adjustable along the oblong hole

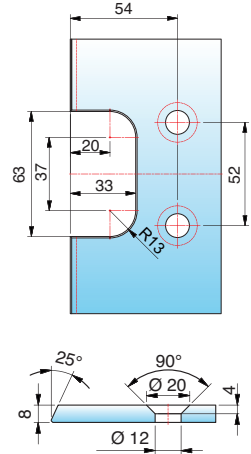
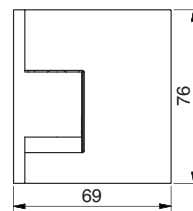
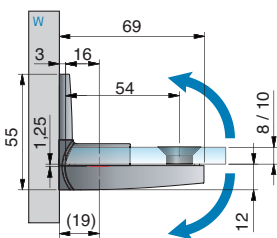
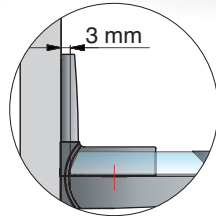

Glasbearbeitung für 8 mm  
mit Dichtprofil 8861KU0-8-2010  
glass processing for 8 mm with  
sealing profile 8861KU0-8-2010

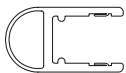

Dichtprofil ausklinken  
Sealing profile notched

Langlochverstellung  
adjustable along the oblong hole

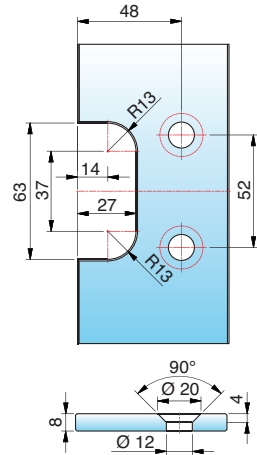
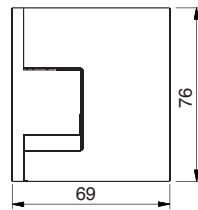
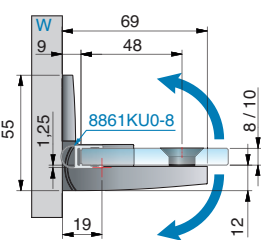
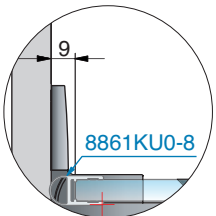

**Black  
EDITION**

Art.-Nr. Art.-no.	Oberfläche Finish	Glasdicke Glass thickness	Artikelbezeichnung Article name	Merkmale Features	VE/Stück Pu/pieces
8390ZNPVD35-L	Schwarz matt Matt black	8/10 mm	PAVONE – Pendeltürband Glas-Wand 90° links montiert, beidseitig öffnend PAVONE – Shower swing door hinge glass-wall 90° Mounted on the left, opening in both directions	Glasbefestigung flächenbündig, verdeckte Verschraubung mit Abdeckkappe, Punkthalter unabhängig voneinander ± 2 mm in jede Richtung verstellbar, Nulllage einstellbar. Verbauung ohne seitliche Dichtung durch geänderte Glasbearbeitung möglich.	1/2
8390ZNPVD36-L	Schwarz glänzend Gloss black			Glass fixtures flush, concealed screws with cover cap, point fixture assembly adjustable independent of each other ± 2 mm in any direction, zero position adjustable. Assembly without side seal possible with altered glass processing.	

MADE  
IN  
GERMANY

# Shower door hinge – PAVONE

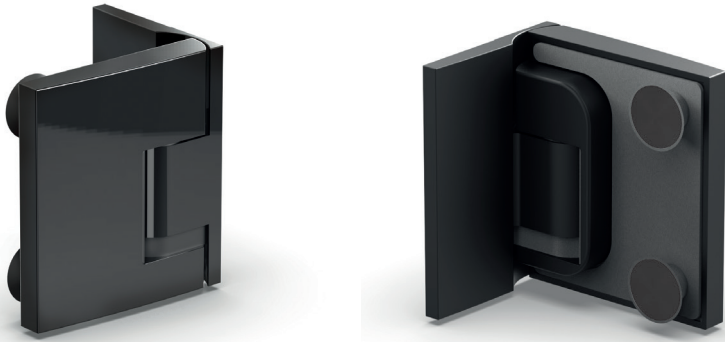

Glasbearbeitung für 8 mm ohne Dichtprofil  
glass processing for 8 mm without sealing profile

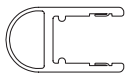
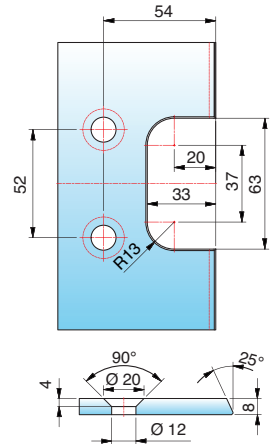
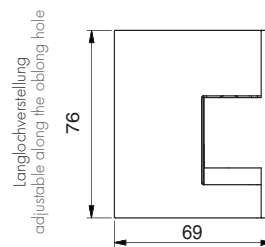
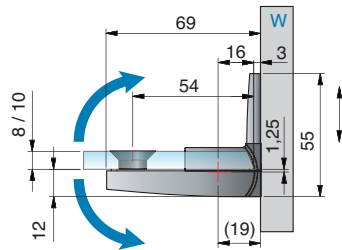
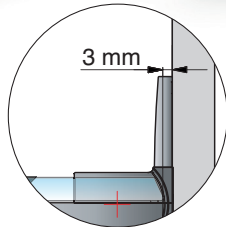

Dichtprofil ausklinken  
Sealing profile notched

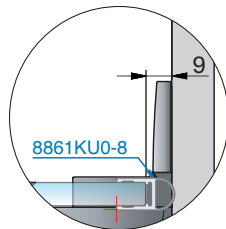

Glasbearbeitung für 8 mm mit Dichtprofil 8861KU0-8-2010  
glass processing for 8 mm with sealing profile 8861KU0-8-2010

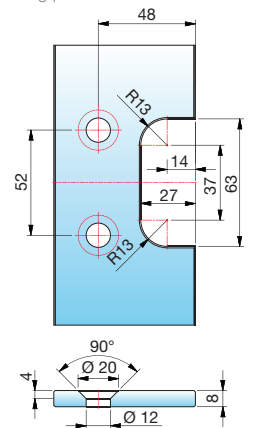
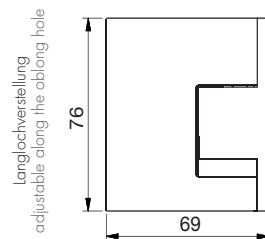
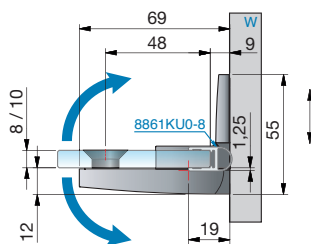

**Black  
EDITION**

Art.-Nr. Art.-no.	Oberfläche Finish	Glasdicke Glass thickness	Artikelbezeichnung Article name	Merkmale Features	VE/Stück Pu/pieces
8390ZNPVD35-R	Schwarz matt Matt black	8/10 mm	PAVONE – Pendeltürband Glas-Wand 90° rechts montiert, beidseitig öffnend PAVONE – Shower swing door hinge glass-wall 90° Mounted on the right, opening in both directions	Glasbefestigung flächenbündig, verdeckte Verschraubung mit Abdeckkappe, Punkthalter unabhängig voneinander ± 2 mm in jede Richtung verstellbar, Nulllage einstellbar. Verbauung ohne seitliche Dichtung durch geänderte Glasbearbeitung möglich.	1/2
8390ZNPVD36-R	Schwarz glänzend Gloss black			Glass fixtures flush, concealed screws with cover cap, point fixture assembly adjustable independent of each other ± 2 mm in any direction, zero position adjustable. Assembly without side seal possible with altered glass processing.	

MADE  
IN  
GERMANY



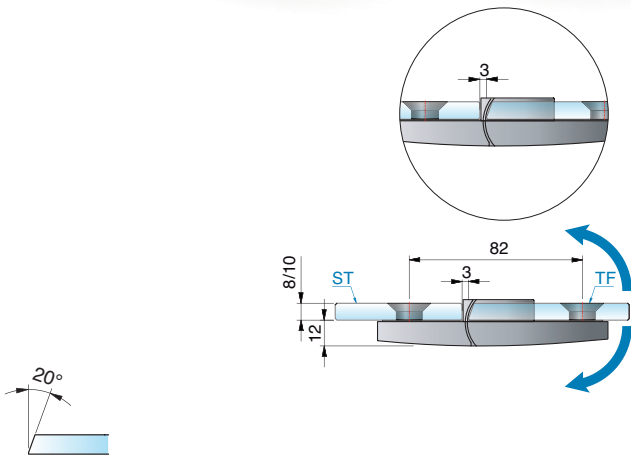

Glasbearbeitung für 8 mm  
ohne Dichtprofil  
glass processing for 8 mm  
without sealing profile

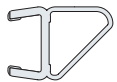
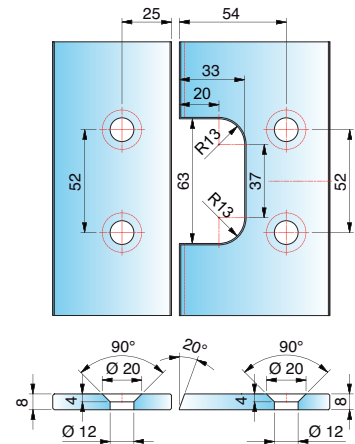

Dichtprofil ausklinken  
Sealing profile notched

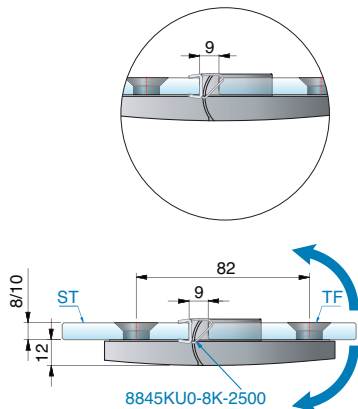

Glasbearbeitung für 8 mm  
mit Dichtprofil 8845KU0-8K-2500  
glass processing for 8 mm with  
sealing profile 8845KU0-8K-2500

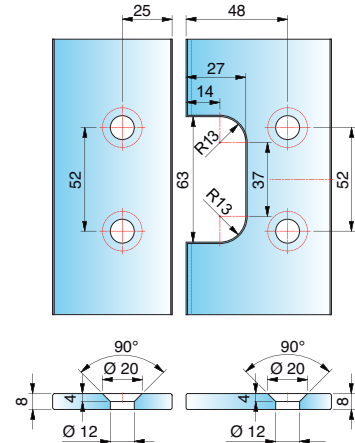

**Black  
EDITION**

Art.-Nr. Art.-no.	Oberfläche Finish	Glasdicke Glass thickness	Artikelbezeichnung Article name	Merkmale Features	VE/Stück Pu/pieces
8392ZNPVD35-L	Schwarz matt Matt black	8/10 mm	Pendeltürband – PAVONE Glas-Wand 180°, links montiert, beidseitig öffnend PAVONE – Shower swing door hinge glass-wall 180°, Mounted on the left, opening in both directions	Glasbefestigung flächenbündig, Punkthalter unabhän- gig voneinander ± 2 mm in jede Richtung verstell- bar, Nulllage einstellbar. Verbauung ohne Dichtung durch geänderte Glasbearbeitung möglich. Glass fixtures flush, point fixture assembly adjustable independent of each other ± 2 mm in any direction, zero position adjustable. Assem- bly without side seal possible with altered glass processing.	1/2
8392ZNPVD36-L	Schwarz glänzend Gloss black				

MADE  
IN  
GERMANY

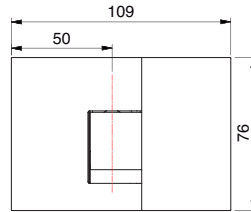
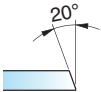
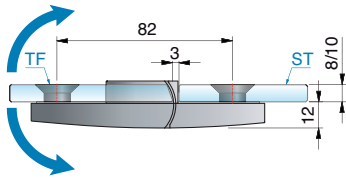
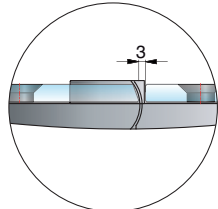

Glasbearbeitung für 8 mm  
ohne Dichtprofil  
glass processing for 8 mm  
without sealing profile

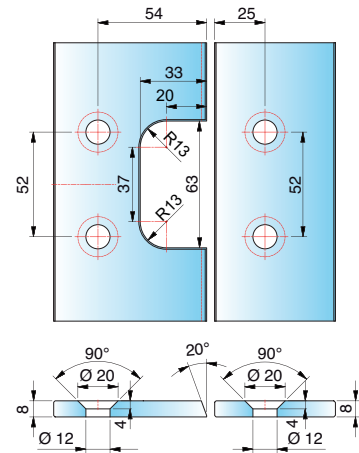

Glasbearbeitung für 8 mm  
mit Dichtprofil 8845KU0-8K-2500  
glass processing for 8 mm with  
sealing profile 8845KU0-8K-2500

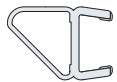
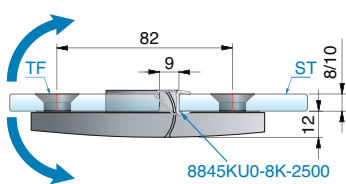
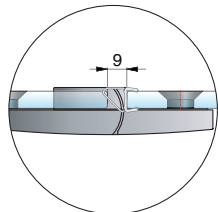

Dichtprofil ausklinken  
Sealing profile notched

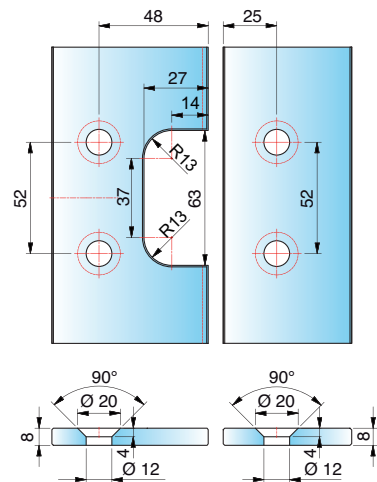
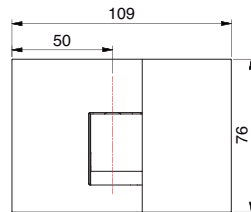

**Black  
EDITION**

Art.-Nr. Art.-no.	Oberfläche Finish	Glasdicke Glass thickness	Artikelbezeichnung Article name	Merkmale Features	VE/Stück Pu/pieces
8392ZNPVD35-R	Schwarz matt Matt black	8/10 mm	Pendeltürband – PAVONE Glas-Wand 180°, rechts montiert, beidseitig öffnend PAVONE – Shower swing door hinge glass-wall 180°, Mounted on the right, opening in both directions	Glasbefestigung flächenbündig, Punkthalter unabhän- gig voneinander ± 2 mm in jede Richtung verstell- bar, Nulllage einstellbar. Verbauung ohne Dichtung durch geänderte Glasbearbeitung möglich. Glass fixtures flush, point fixture assembly adjustable independent of each other ± 2 mm in any direction, zero position adjustable. Assem- bly without side seal possible with altered glass processing.	1/2
8392ZNPVD36-R	Schwarz glänzend Gloss black	8/10 mm	Pendeltürband – PAVONE Glas-Wand 180°, rechts montiert, beidseitig öffnend PAVONE – Shower swing door hinge glass-wall 180°, Mounted on the right, opening in both directions	Glasbefestigung flächenbündig, Punkthalter unabhän- gig voneinander ± 2 mm in jede Richtung verstell- bar, Nulllage einstellbar. Verbauung ohne Dichtung durch geänderte Glasbearbeitung möglich. Glass fixtures flush, point fixture assembly adjustable independent of each other ± 2 mm in any direction, zero position adjustable. Assem- bly without side seal possible with altered glass processing.	1/2

MADE  
IN  
GERMANY



# Winkelverbinder- PAVONE



Langlochverstellung  
adjustable along the elongated hole

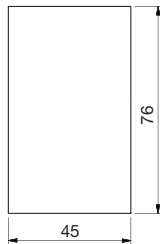
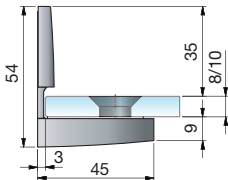

Glasbearbeitung für 8 mm  
glass processing for 8 mm

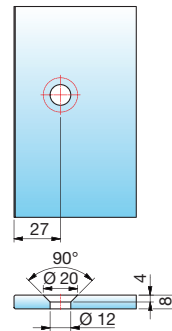

**Black  
EDITION**

Art.-Nr. Art.-no.	Oberfläche Finish	Glasdicke Glass thickness	Artikelbezeichnung Article name	Merkmale Features	VE/Stück Pu/pieces
8398ZNPVD35	Schwarz matt Matt black	8/10 mm	PAVONE – Winkelverbinder Glas-Wand 90° PAVONE – Corner bracket glass-wall, 90°	Glasbefestigung flächenbündig, Lasche innen mit Langlochverstellung, Abdeckkappe, Punkthalter ± 2 mm in jede Richtung verstellbar Glass mount flush, bracket inside with long hole adjustment, cover cap, point fixtures adjustable ± 2mm in any direction	1/2
8398ZNPVD36	Schwarz glänzend Gloss black				

MADE  
IN  
GERMANY



Glasbearbeitung für 8 mm  
glass processing for 8 mm

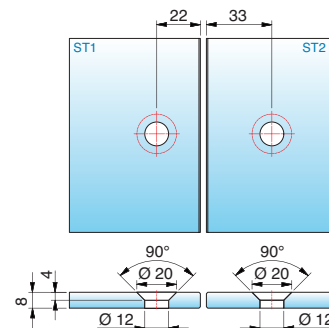
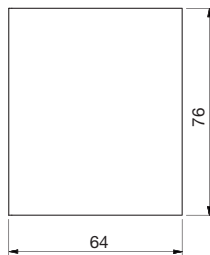
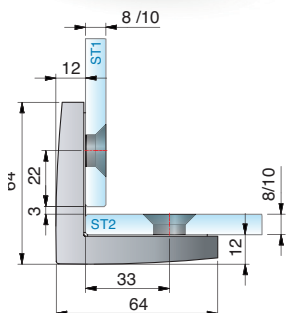

**Black  
EDITION**

Art.-Nr. Art.-no.	Oberfläche Finish	Glasdicke Glass thickness	Artikelbezeichnung Article name	Merkmale Features	VE/Stück Pu/pieces
8399ZNPVD35	Schwarz matt Matt black	8/10 mm	PAVONE – Winkelverbinder Glas-Glas 90° PAVONE – Corner bracket glass-glass, 90°	Glasbefestigung flächenbündig, Abdeckkappe, Punkthalter ± 2 mm in jede Richtung verstellbar Glass mount flush, cover cap, point fixtures adjustable ± 2mm in any direction	1/2
8399ZNPVD36	Schwarz glänzend Gloss black				

MADE  
IN  
GERMANY







# FLAMEA+

Die Serie FLAMEA+ wurde für Duschen der Top-Klasse entwickelt. Die optimale Einbausituation: Ganzglasduschen in XL-Formate FLAMEA+ erfüllt alle ästhetischen und funktionalen Ansprüche für den Objekt- und Privatbereich.

- beidseitig 90° öffnendes Duschpendeltürband
- auf den letzten Zentimetern selbstschließend
- mittig liegender Drehpunkt und daher als Pendeltür nutzbar
- stufenlose Nulllageneinstellung
- Tragfähigkeit (2 Bänder): 45 kg entsprechen einer maximalen Türflügelgröße von 900 x 2000 mm bei 10 mm Glasdicke
- optimiert für die Verbauung ohne Dichtprofil
- keine sichtbare Verschraubung
- minimierte Spaltmaße und daher dichter
- Die Haltbarkeit der Beschläge wurde durch werksinterne Versuche nach DIN EN 14428:2015 5.5 geprüft.

The FLAMEA+ series was developed for showers of the top class. The optimum installation situation: Glass showers in XL-format. FLAMEA+ meets all aesthetic and functional requirements for projects and private homes.

- 90° double-sided shower swing door hinge
- with self-regulated closing on the last centimeters
- centered pivot-point, therefore usage as swing door possible
- infinitely variable zero position,
- loading capacity (2 hinges): 45 kg corresponding to a glass door with the dimension 900 x 2000 mm and a glass thickness of 10 mm
- optimized for installation without sealing profile
- invisible screw connections
- minimized gap distance
- The durability of the hardware were tested internally in accordance with DIN EN 14428:2015 5.5.







# Duschtürband – FLAMEA+



Schwarz matt  
Matt black



Schwarz glänzend  
Gloss black

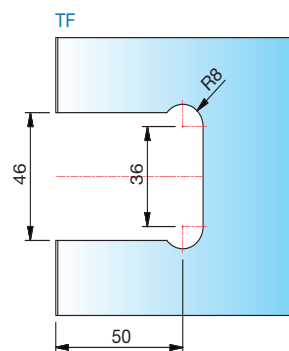
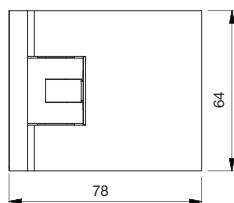
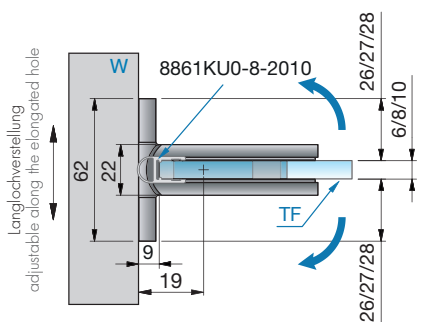
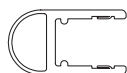
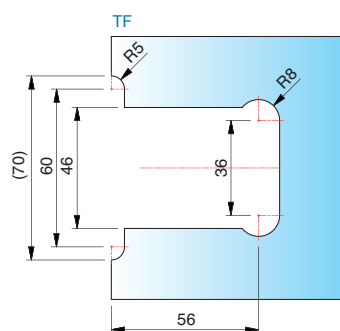
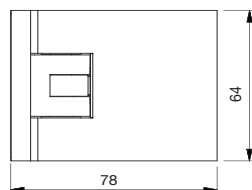
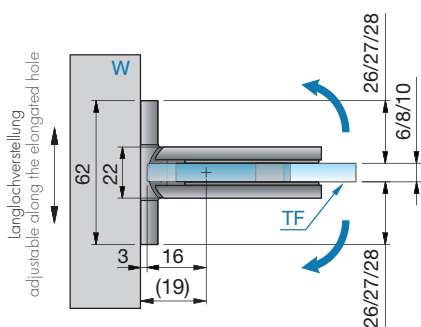
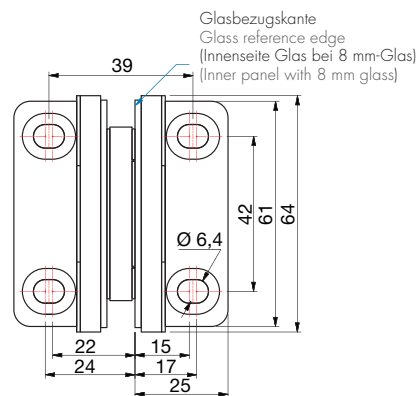

**Black  
EDITION**

Art.-Nr. Art.-no.	Oberfläche Finish	Glasdicke Glass thickness	Artikelbezeichnung Article name	Merkmale Features	VE/Stück Pc/pieces
8134ZNPVD35	Schwarz matt Matt black	6/8/10 mm	Duschpendeltürband FLAMEA+ Glas-Wand 90°	beidseitig 90° öffnend, mit verstellbarer Nulllagenstellung, Langlochverstellung, beidseitige Befestigungsglasche verdeckte Verschraubung mit Abdeckkappe	1/2
8134ZNPVD36	Schwarz glänzend Gloss black		Shower swing door hinge FLAMEA+ glass-wall, 90°	double sided opening 90°, with adjustable zero position, adjustable within the notch, one sided mounting plate, invisible screw connections due to coverage	

MADE  
IN  
GERMANY

# Shower door hinge – FLAMEA+



Glasbearbeitung für 8 mm ohne  
Dichtprofil | glass processing  
for 8 mm without sealing profile

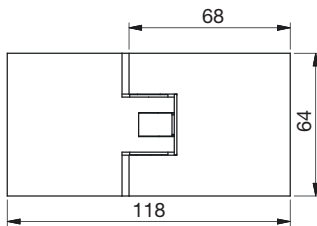
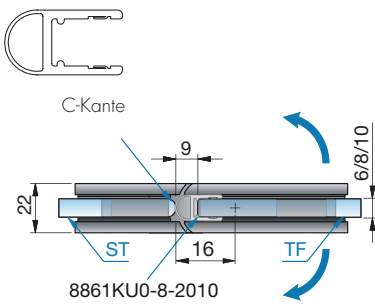
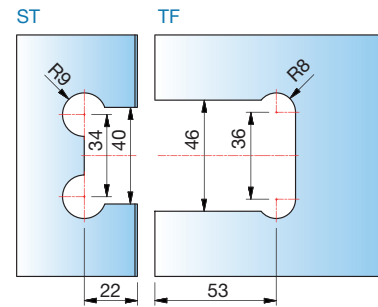
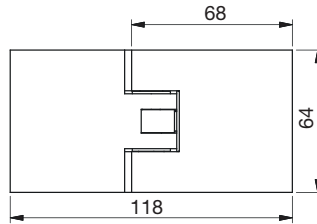
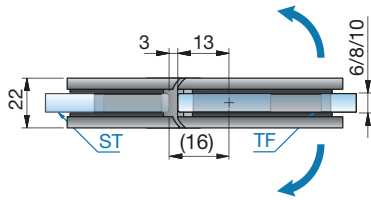

Glasbearbeitung für 8 mm mit  
Dichtprofil 8861KU0-8-2010  
glass processing for 8 mm with  
sealing profile 8861KU0-8-2010

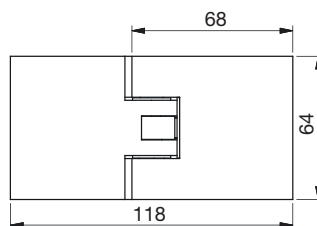
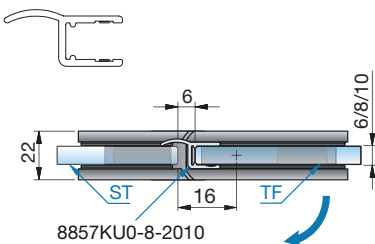
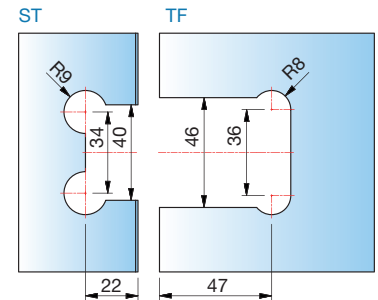

Glasbearbeitung für 8 mm mit  
Dichtprofil 8857KU0-8-2010  
glass processing for 8 mm with  
sealing profile 8857KU0-8-2010

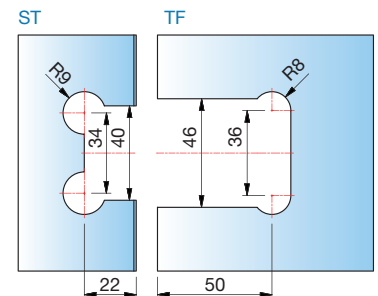

**Black  
EDITION**

Art.-Nr. Art.-no.	Oberfläche Finish	Glasdicke Glass thickness	Artikelbezeichnung Article name	Merkmale Features	VE/Stück Pu/pieces
8132ZNPVD35	Schwarz matt Matt black	6/8/10 mm	Duschpendeltürband FLAMEA+ Glas-Glas 180° Shower swing door hinge FLAMEA+ glass-glass, 180°	je nach Dichtung beidseitig 90° öffnend, mit verstellbarer Nullagenstellung, verdeckte Verschraubung mit Abdeckkappe opening in both directions 90° depending on sealing profile, with adjustable zero position, adjustable within the notch, invisible screw-connections due to coverage	1/2
8132ZNPVD36	Schwarz glänzend Gloss black				

MADE  
IN  
GERMANY



# Duschtürband – FLAMEA+ | Shower door hinge – FLAMEA+



Schwarz matt  
Matt black



Schwarz glänzend  
Gloss black

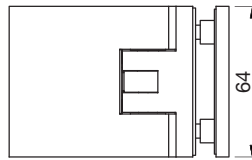
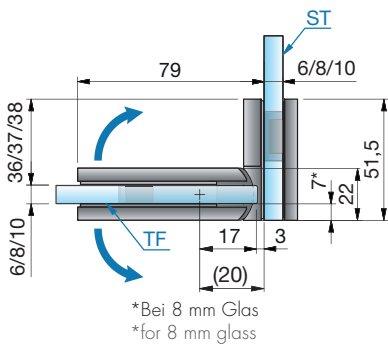

Glasbearbeitung für 8 mm ohne Dichtprofil | glass processing for 8 mm without sealing profile

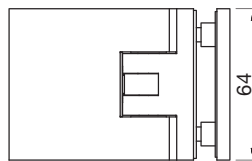
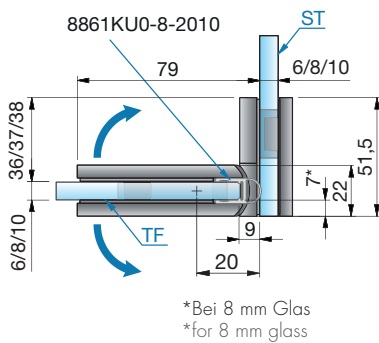
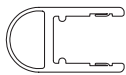
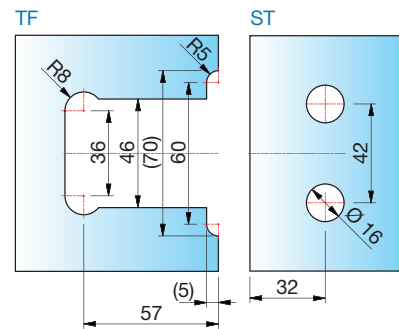

Glasbearbeitung für 8 mm mit Dichtprofil 8861KU0-8-2010 | glass processing for 8 mm with sealing profile 8861KU0-8-2010

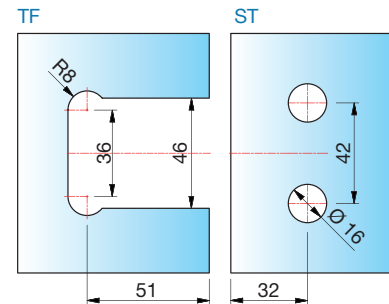

**Black  
EDITION**

Art.-Nr. Art.-no.	Oberfläche Finish	Glasdicke Glass thickness	Artikelbezeichnung Article name	Merkmale Features	VE/Stück Pu/pieces
8136ZNPVD35	Schwarz matt Matt black	6/8/10 mm	Duschpendeltürband FLAMEA+ Glas-Glas 90° Shower swing door hinge FLAMEA+ glass-glass, 90°	beidseitig 90° öffnend, mit verstellbarer Nulllagenstellung, verdeckte Verschraubung mit Abdeckkappe double sided opening 90°, with adjustable zero position, invisible screw-connections due to cover-age	1/2
8136ZNPVD36	Schwarz glänzend Gloss black				

MADE  
IN  
GERMANY

# Winkelverbinder | Corner bracket



Schwarz matt  
Matt black



Schwarz glänzend  
Gloss black

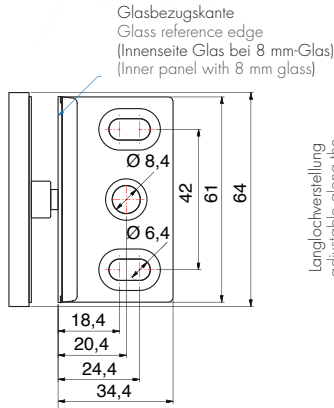

Langlochverstellung  
adjustable along the  
elongated hole

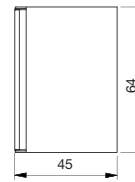
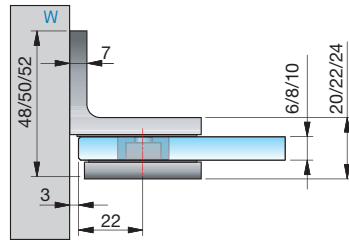

Glasbearbeitung für 6/8/10 mm  
glass processing for 6/8/10 mm

Bohrung Ø 20 mm oder Randausschnitt R35  
bore Ø 20 mm or cutout R35

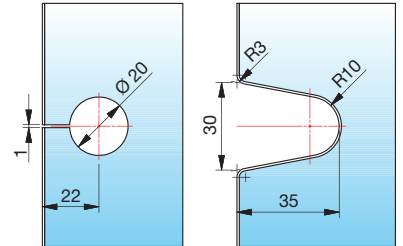

**Black**  
EDITION

Art.-Nr. Art.-no.	Oberfläche Finish	Glasdicke Glass thickness	Artikelbezeichnung Article name	Merkmale Features	VE/Stück Pu/pieces
8194ZNPVD35	Schwarz matt Matt black	6/8/10 mm	Winkelverbinder FLAMEA+ Glas-Wand 90° Corner bracket FLAMEA+ glass-wall, 90°	Wandbefestigung mit Langlochverstellung, verdeckte Verschraubung mit Abdeckkappe adjustable within the notch invisible screw- connections due to coverage	1/2
8194ZNPVD36	Schwarz glänzend Gloss black				

MADE  
IN  
GERMANY



Schwarz matt  
Matt black



Schwarz glänzend  
Gloss black

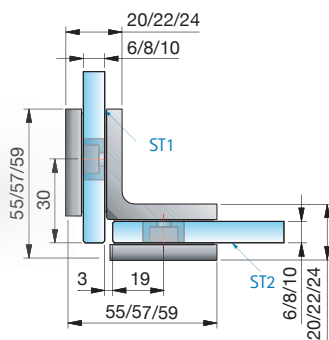

Glasbearbeitung für 8 mm  
glass processing for 8 mm

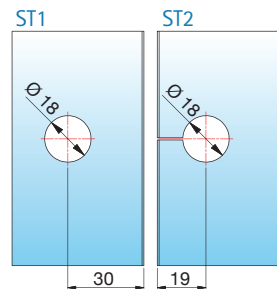
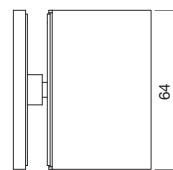

**Black**  
EDITION

Art.-Nr. Art.-no.	Oberfläche Finish	Glasdicke Glass thickness	Artikelbezeichnung Article name	Merkmale Features	VE/Stück Pu/pieces
8196ZNPVD35	Schwarz matt Matt black	6/8/10 mm	Winkelverbinder FLAMEA+ Glas-Glas 90° Corner bracket FLAMEA+ glass-glass, 90°	verdeckte Verschraubung mit Abdeckkappe invisible screw-connections due to coverage	1/2
8196ZNPVD36	Schwarz glänzend Gloss black				

MADE  
IN  
GERMANY





# FLAMEA+ SN

**Black  
EDITION**

Mit dem Saunabeschlag FLAMEA<sup>+</sup>-SN von Pauli + Sohn lassen sich individuelle Wellness-Oasen planen – von der kleinen Privatsauna bis hin zur großzügigen Saunalandschaft. Werkseigene Tests bestätigen die optimale Funktionalität bei Einhaltung der vorgeschriebenen Türmaße und deren Gewichte sowie der maximal zulässigen Umgebungstemperatur von 100° C.

The lightness and transparency of glass offer the pleasant and comfortable feeling to melt with the bath. You are able to realize individual oases of well-being with our new sauna hinge FLAMEA<sup>+</sup>-SN from Pauli + Sohn – from a small niche-sauna to a generous sauna wellness world.

- beidseitig 90° öffnendes Sauna-Pendeltürband
- minimierte Spaltmaße für den Einsatz im Saunabereich
- auf den letzten Zentimetern selbstschließend
- mittig liegender Drehpunkt und daher als Pendeltür nutzbar
- stufenlose Nulllageneinstellung
- hervorragende Qualität – "made in Germany" – Bei der Produktion der Saunabeschläge werden Materialien eingesetzt, welche diesen speziellen Anforderungen entsprechen und standhalten.

- 90° double sided shower swing door hinge
- minimized gap distances for the installation in a sauna
- automated closing on the last centimeters
- centered pivot-point, therefore usage as swing door possible
- infinitely variable zero position
- invisible screw connection

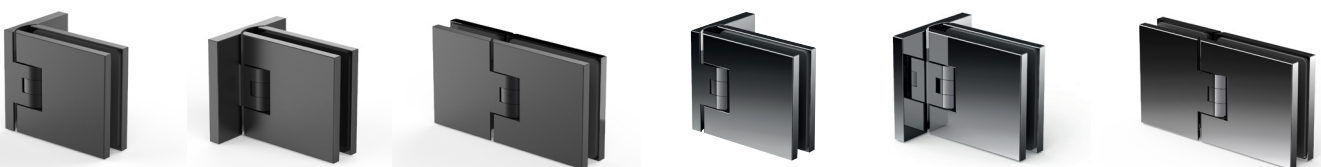

# Sauna-Pendeltürband - FLAMEA+ | Sauna swing door hinge - FLAMEA+



Schwarz matt  
Matt black

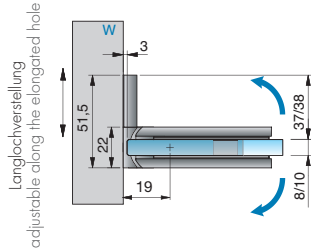

Schwarz glänzend  
Gloss black

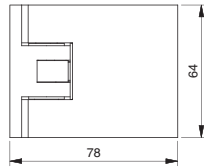

Glasbearbeitungen für die unterschiedlichen Spaltmaße  
Glass processing for different gap dimensions

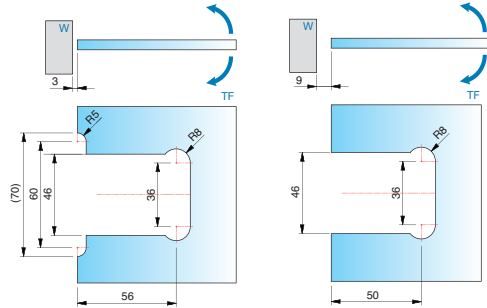

**Black  
EDITION**

Art.-Nr. Art.-no.	Oberfläche Finish	Glasdicke Glass thickness	Artikelbezeichnung Article name	Merkmale Features	VE/Stück Pu/pieces
8130ZNPVD35-SN	Schwarz matt Matt black	8/10 mm	Sauna-Pendeltürband FLAMEA+, Glas-Wand 90°, max. Türbreite 800 mm, Tragfähigkeit (2 Bänder): 32 kg bei max. 800 x 2000 x 8 mm Sauna swing door hinge FLAMEA+, glass-wall, 90°, max. door width 800 mm	beidseitig 90° öffnend, mit verstellbarer Nulllagenstellung, Langlochverstellung, einseitige Befestigungslasche, verdeckte Verschraubung mit Abdeckkappe double sided opening 90°, with adjustable zero position, adjustable within the notch, one sided mounting plate, invisible screw connections due to coverage	1/2
8130ZNPVD36-SN	Schwarz glänzend Gloss black				

MADE  
IN  
GERMANY



Schwarz matt  
Matt black

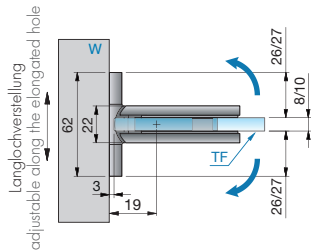

Schwarz glänzend  
Gloss black

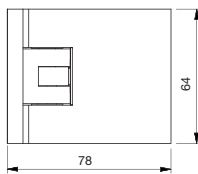

Glasbearbeitungen für die unterschiedlichen Spaltmaße  
Glass processing for different gap dimensions

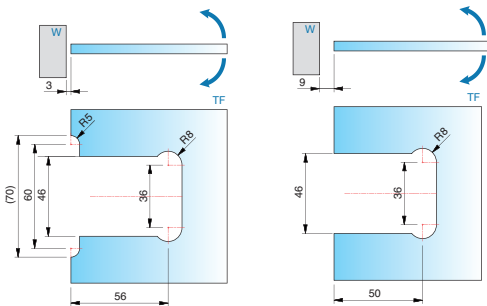

**Black  
EDITION**

Art.-Nr. Art.-no.	Oberfläche Finish	Glasdicke Glass thickness	Artikelbezeichnung Article name	Merkmale Features	VE/Stück Pu/pieces
8134ZNPVD35-SN	Schwarz matt Matt black	8/10 mm	Sauna-Pendeltürband FLAMEA+, Glas-Wand 90°, max. Türbreite 900 mm, Tragfähigkeit (2 Bänder): 36 kg bei max. 900 x 2000 x 8 mm Sauna swing door hinge FLAMEA+, glass-wall, 90°, max. door width 900 mm	beidseitig 90° öffnend, mit verstellbarer Nulllagenstellung, Langlochverstellung, beidseitige Befestigungslasche, verdeckte Verschraubung mit Abdeckkappe double sided opening 90°, with adjustable zero position, adjustable within the notch, double sided mounting plate, invisible screw connections due to coverage	1/2
8134ZNPVD36-SN	Schwarz glänzend Gloss black				

MADE  
IN  
GERMANY

# Sauna-Pendeltürband - FLAMEA<sup>+</sup>

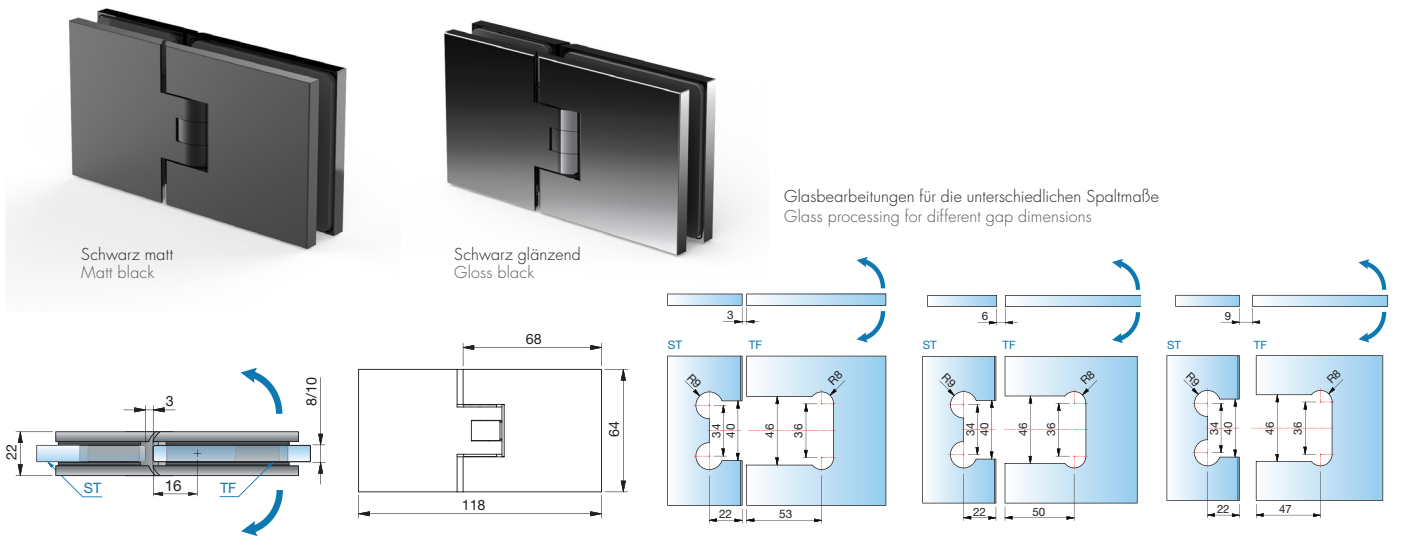

Glasbearbeitungen für die unterschiedlichen Spaltmaße  
Glass processing for different gap dimensions

**Black  
EDITION**

Art.-Nr. Art.-no.	Oberfläche Finish	Glasdicke Glass thickness	Artikelbezeichnung Article name	Merkmale Features	VE/Stück Pu/pieces
8132ZNPVD35-SN	Schwarz matt Matt black	8/10 mm	Sauna-Pendeltürband FLAMEA <sup>+</sup> , Glas-Glas 180°, max. Türbreite 750 mm, Tragfähigkeit (2 Bänder): 30 kg bei max. 750 x 2000 x 8 mm	je nach Dichtung beidseitig 90° öffnend, mit verstellbarer Nulllagenstellung, verdeckte Verschraubung mit Abdeckkappe double sided opening 90°, with adjustable zero position, adjustable within the notch, invisible screw connections due to coverage	1/2
8132ZNPVD36-SN	Schwarz glänzend Gloss black		Sauna swing door hinge FLAMEA <sup>+</sup> , glass-glass 180°, max. door width 750 mm		

MADE  
IN  
GERMANY

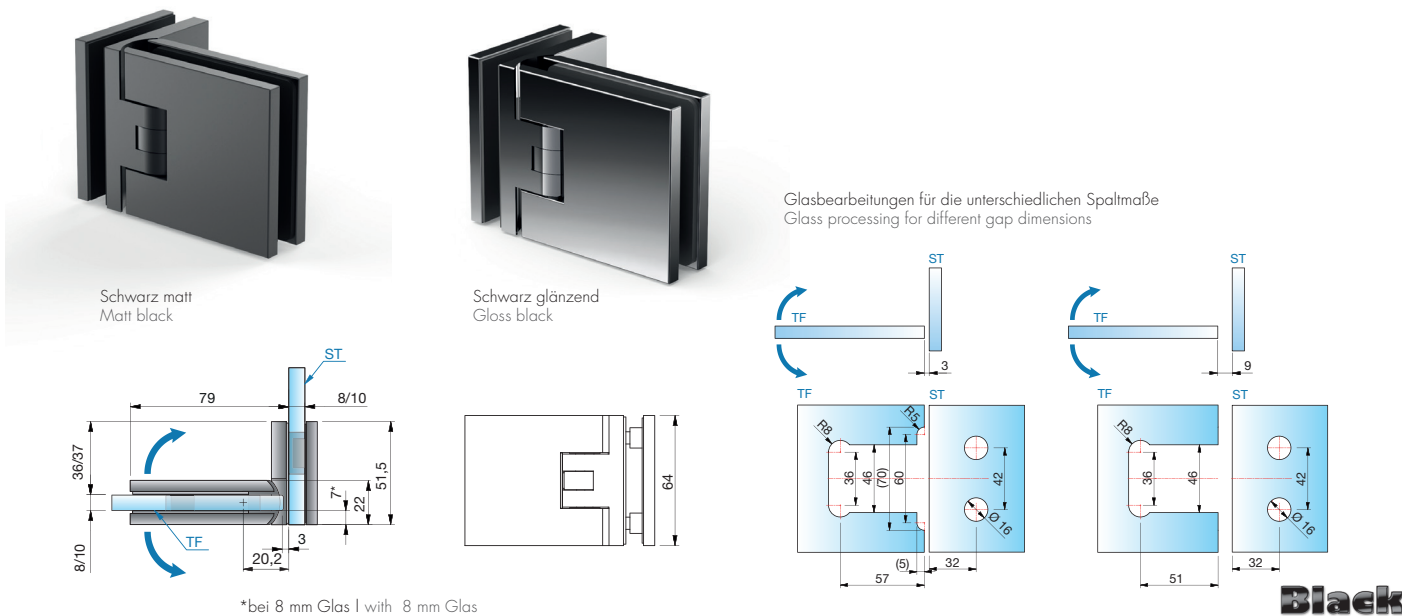

Glasbearbeitungen für die unterschiedlichen Spaltmaße  
Glass processing for different gap dimensions

**Black  
EDITION**

Art.-Nr. Art.-no.	Oberfläche Finish	Glasdicke Glass thickness	Artikelbezeichnung Article name	Merkmale Features	VE/Stück Pu/pieces
8136ZNPVD35-SN	Schwarz matt Matt black	8/10 mm	Sauna-Pendeltürband FLAMEA <sup>+</sup> , Glas-Glas 90°, max. Türbreite 800 mm, Tragfähigkeit (2 Bänder): 32 kg bei max. 800 x 2000 x 8 mm	beidseitig 90° öffnend, mit verstellbarer Nulllagenstellung, verdeckte Verschraubung mit Abdeckkappe double sided opening 90°, with adjustable zero position, adjustable within the notch, invisible screw connections due to coverage	1/2
8136ZNPVD36-SN	Schwarz glänzend Gloss black		Sauna swing door hinge FLAMEA <sup>+</sup> , glass-glass 90°, max. door width 800 mm		

MADE  
IN  
GERMANY



# Sauna swing door hinge - FLAMEA<sup>+</sup>



Schwarz matt  
Matt black



Schwarz glänzend  
Gloss black

Langlochverstellung  
adjustable along the elongated hole

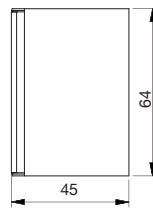
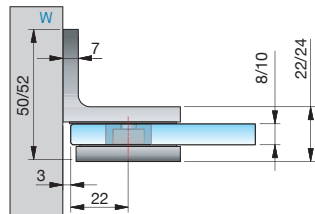

Glasbearbeitung für 6/8/10 mm  
glass processing for 6/8/10 mm

Bohrung Ø 20 mm oder Randausschnitt R35  
bore Ø 20 mm or cutout R35

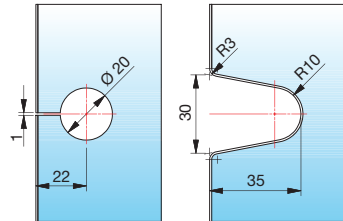

**Black  
EDITION**

Art.-Nr. Art.-no.	Oberfläche Finish	Glasdicke Glass thickness	Artikelbezeichnung Article name	Merkmale Features	VE/Stück Pu/pieces
8194ZNPVD35-SN	Schwarz matt Matt black	6/8/10 mm	Sauna-Winkelverbinder FLAMEA <sup>+</sup> , Glas-Wand 90° Corner bracket FLAMEA <sup>+</sup> glass-wall, 90°	Wandbefestigung mit Langlochverstellung, verdeckte Verschraubung mit Abdeckkappe adjustable within the notch invisible screw- connections due to coverage	1/2
8194ZNPVD36-SN	Schwarz glänzend Gloss black				

MADE  
IN  
GERMANY



Schwarz matt  
Matt black



Schwarz glänzend  
Gloss black

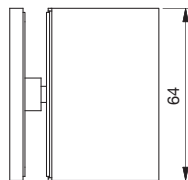
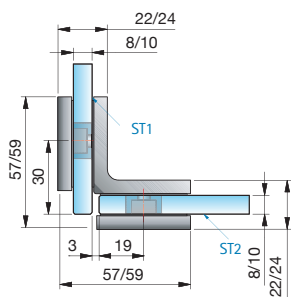

Glasbearbeitung für 8 mm  
glass processing for 8 mm

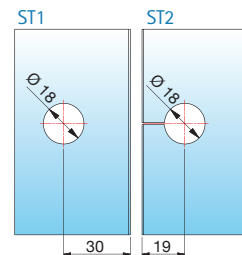

**Black  
EDITION**

Art.-Nr. Art.-no.	Oberfläche Finish	Glasdicke Glass thickness	Artikelbezeichnung Article name	Merkmale Features	VE/Stück Pu/pieces
8196ZNPVD35-SN	Schwarz matt Matt black	6/8/10 mm	Sauna-Winkelverbinder FLAMEA <sup>+</sup> , Glas-Glas 90° Corner bracket FLAMEA <sup>+</sup> glass-glass, 90°	verdeckte Verschraubung mit Abdeckkappe invisible screw-connections due to coverage	1/2
8196ZNPVD36-SN	Schwarz glänzend Gloss black				

MADE  
IN  
GERMANY



# FARFALLA

FARFALLA ist ein Band von zuverlässiger Funktionalität und zeitlosem Erscheinungsbild. Das Anschlagtürband ohne definierte Nulllageneinstellung öffnet sich einseitig nach außen oder innen – in Kombination mit PONTERE lassen sich auch Falthanlagen realisieren. Ein Duschband für den Objekt- und Privatbereich. Höchste Qualität zu einem marktgerechten Preis.

- verdeckte Verschraubung mit Abdeckkappe
- einseitig nach außen oder innen hin öffnendes Anschlagtürband
- Montage mit durchgehender Dichtung möglich
- alle Sets nach DIN EN 14428 geprüft
- Bandachse außerhalb der Glasflucht positioniert, deshalb ein komplettes Falten der Glaselemente möglich
- Glasdicke: 6, 8 und 10 mm
- Tragfähigkeit (2 Bänder): 40 kg entspricht einer maximalen Türflügelgröße von 1000 x 2000 mm bei 8 mm Glasdicke
- Die Haltbarkeit der Beschläge wurde durch werksinterne Versuche nach DIN EN 14428:2015 5.5 geprüft.

FARFALLA is a hinge with reliable functionality and timeless appearance. The striker hinge without a defined closed position opens either inwards or outwards - in combination with PONTERE a folding installation can be realized. A shower hinge for projects or private homes. Highest quality at a fair market price.

- invisible screw-connections due to coverage
- door hinge opens outwards or inwards on one side
- assembling with throughout sealing profile possible
- all installations and sets are tested according to DIN EN 14428
- the hinge axis is positioned outside of the glass door so that the glass segments can also be folded completely
- Glass thickness: 6, 8 und 10 mm
- load capacity (2 hinges): 40 kg corresponding to a glass door of 1000 x 2000 mm with glass thickness of 8 mm
- The durability of the hardware were tested internally in accordance with DIN EN 14428:2015 5.5.



# Duschtürband – FARFALLA | Shower door hinge – FARFALLA



Schwarz matt  
Matt black



Schwarz glänzend  
Gloss black

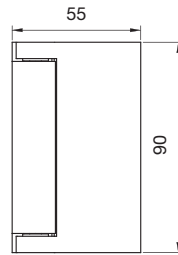
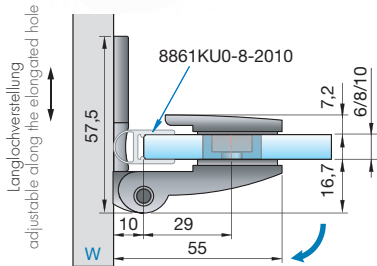

Glasbearbeitung für 8 mm  
glass processing for 8 mm

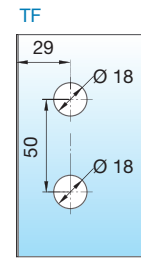

**Black**  
EDITION

Art.-Nr. Art.-no.	Oberfläche Finish	Glasdicke Glass thickness	Artikelbezeichnung Article name	Merkmale Features	VE/Stück Pu/pieces
8128ZN35	RAL9005 Schwarz matt Matt black	6/8/10 mm	Duschtürband FARFALLA Glas-Wand 90° shower door hinge FARFALLA glass-wall, 90°	90° nach außen hin öffnend, Wandbefestigung mit Langlochverstellung und Abdeckplatte, durchgehende Dichtung, verdeckte Verschraubung mit Abdeckkappe	1/2
8128ZN36	RAL9005 Schwarz glänzend Gloss black			opening outwards 90°, wall mount adjustable with the notch, comes with cover plate, end-to-end sealing profile invisible screw-connections due to coverage	

MADE  
IN  
GERMANY



Schwarz matt  
Matt black



Schwarz glänzend  
Gloss black

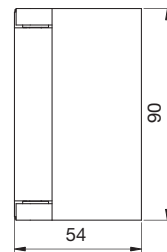
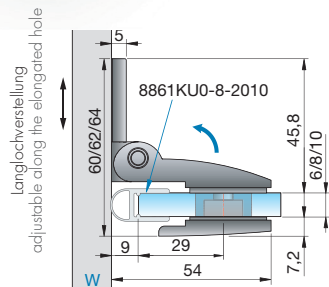

Glasbearbeitung für 8 mm  
glass processing for 8 mm

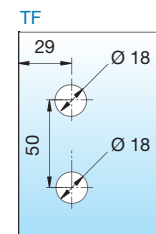

**Black**  
EDITION

Art.-Nr. Art.-no.	Oberfläche Finish	Glasdicke Glass thickness	Artikelbezeichnung Article name	Merkmale Features	VE/Stück Pu/pieces
8120ZN35	RAL9005 Schwarz matt Matt black	6/8/10 mm	Duschtürband FARFALLA Glas-Wand 90° shower door hinge FARFALLA glass-wall, 90°	90° nach innen hin öffnend, Wandbefestigung mit Langlochverstellung und Abdeckplatte, durchgehende Dichtung, verdeckte Verschraubung mit Abdeckkappe	1/2
8120ZN36	RAL9005 Schwarz glänzend Gloss black			opening inward 90°, wall mount adjustable with the notch, comes with cover plate, end-to-end sealing profile invisible screw-connections due to coverage	

MADE  
IN  
GERMANY



# Duschtürband – FARFALLA | Shower door hinge – FARFALLA



Schwarz matt  
Matt black



Schwarz glänzend  
Gloss black

Glasbearbeitung für 8 mm  
glass processing for 8 mm

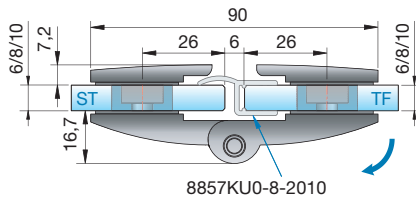

8857KU0-8-2010

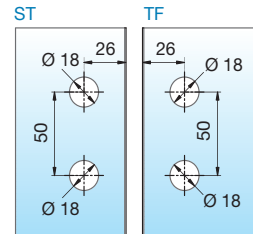
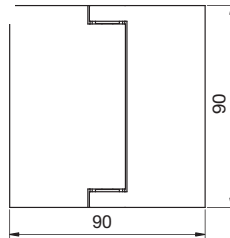

**Black  
EDITION**

Art.-Nr. Art.-no.	Oberfläche Finish	Glasdicke Glass thickness	Artikelbezeichnung Article name	Merkmale Features	VE/Stück Pu/pieces
8122ZN35	RAL9005 Schwarz matt Matt black	6/8/10 mm	Duschtürband FARFALLA Glas-Glas 180° shower door hinge FARFALLA LA glass-glass, 180°	180° nach außen hin öffnend, durchgehende Dichtung, verdeckte Verschraubung mit Abdeckkappe opening outwards 180°, end-to-end sealing profile invisible screw-connections due to coverage	1/2
8122ZN36	RAL9005 Schwarz glänzend Gloss black				

MADE  
IN  
GERMANY



Schwarz glänzend  
Gloss black

Glasbearbeitung für 8 mm  
glass processing for 8 mm

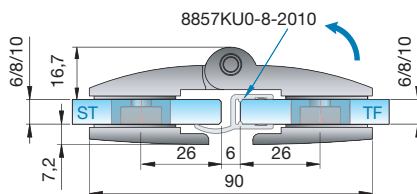

8857KU0-8-2010

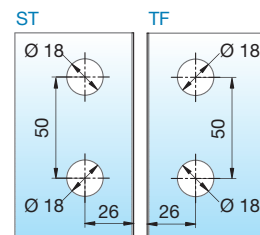
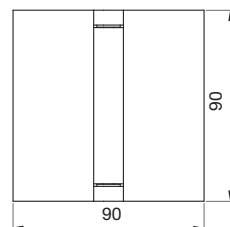

**Black  
EDITION**

Art.-Nr. Art.-no.	Oberfläche Finish	Glasdicke Glass thickness	Artikelbezeichnung Article name	Merkmale Features	VE/Stück Pu/pieces
8124ZN35	RAL9005 Schwarz matt Matt black	6/8/10 mm	Duschtürband FARFALLA Glas-Glas 180° shower door hinge FARFALLA glass-glass, 180°	180° nach innen hin öffnend, durchgehende Dichtung, verdeckte Verschraubung mit Abdeckkappe opening inward 180°, end-to-end sealing profile invisible screw-connections due to coverage	1/2
8124ZN36	RAL9005 Schwarz glänzend Gloss black				

MADE  
IN  
GERMANY

# Winkelverbinder | Corner bracket



Schwarz matt  
Matt black



Schwarz glänzend  
Gloss black

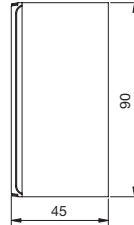
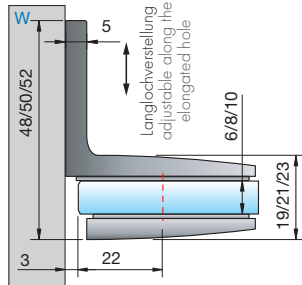

Glasbearbeitung für 8 mm  
glass processing for 8 mm

Bohrung  $\varnothing$  20 mm oder Randausschnitt R35  
bore  $\varnothing$  20 mm or cutout R35

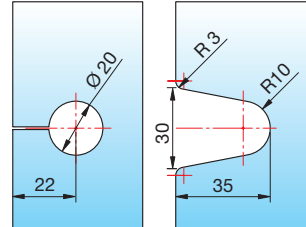

**Black**  
EDITION

Art.-Nr. Art.-no.	Oberfläche Finish	Glasdicke Glass thickness	Artikelbezeichnung Article name	Merkmale Features	VE/Stück Pu/pieces
8107ZN35	RAL9005 Schwarz matt Matt black	6/8/10 mm	Winkelverbinder Glas-Wand 90° corner bracket, glass-wall, 90°	Wandbefestigung mit Langlochverstellung, starr verdeckte Verschraubung mit Abdeckkappe wall mount adjustable within the notch and comes with cover plate invisible screw-connections due to coverage	1/2
8107ZN36	RAL9005 Schwarz glänzend Gloss black				

MADE  
IN  
GERMANY



Schwarz matt  
Matt black



Schwarz glänzend  
Gloss black

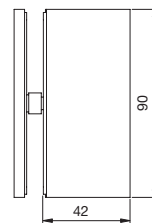
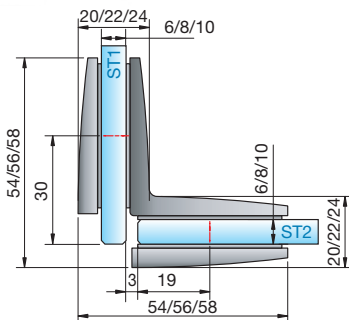

Glasbearbeitung für 8 mm  
glass processing for 8 mm

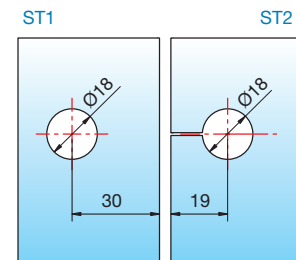

**Black**  
EDITION

Art.-Nr. Art.-no.	Oberfläche Finish	Glasdicke Glass thickness	Artikelbezeichnung Article name	Merkmale Features	VE/Stück Pu/pieces
8109ZN35	RAL9005 Schwarz matt Matt black	6/8/10 mm	Winkelverbinder Glas-Glas 90° corner bracket, glass-glass, 90°	verdeckte Verschraubung mit Abdeckkappe invisible screw-connections due to coverage	1/2
8109ZND36	RAL9005 Schwarz glänzend Gloss black				

MADE  
IN  
GERMANY



# GRIFFE | DOOR HANDLES

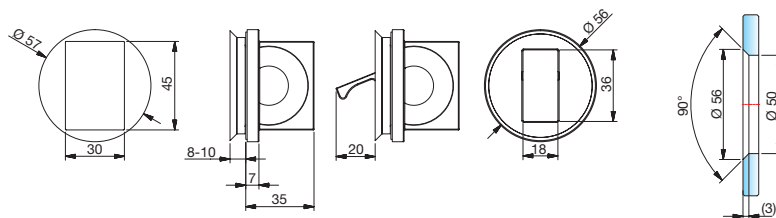

Art.-Nr. Art.-no.	Oberfläche Finish	Glasdicke Glass thickness	Artikelbezeichnung Article name	VE/Stück Pu/pieces
8379ZNPVD35	Schwarz matt Matt black	8-10 mm	Glastürgriff flächenbündig glass door handle flush	1/1
8379ZNPVD36	Schwarz glänzend Gloss black			



\*Bei 8 mm Glas  
\*for 8 mm glass

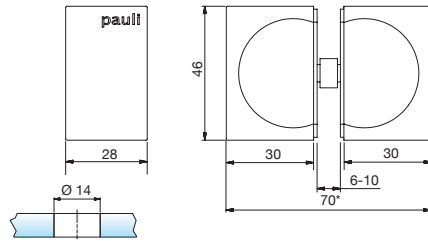

**Black  
EDITION**

Art.-Nr. Art.-no.	Oberfläche Finish	Glasdicke Glass thickness	Artikelbezeichnung Article name	VE/Stück Pu/pieces
8278MSPVD35-A	Schwarz matt Matt black	6-10 mm	Glastürgriff beidseitig ohne Logoeindruck glass door handle without logo	1/1
8278MSPVD36-A	Schwarz glänzend Gloss black			

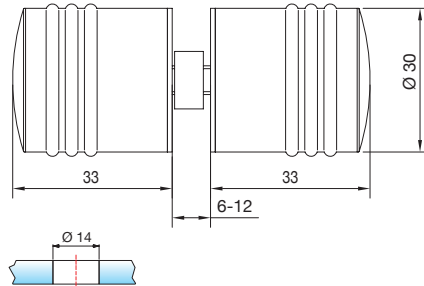

**Black  
EDITION**

Art.-Nr. Art.-no.	Oberfläche Finish	Glasdicke Glass thickness	Artikelbezeichnung Article name	VE/Stück Pu/pieces
8298MS35	RAL9005 Schwarz Matt RAL9005 Matt black	6-12 mm	Glastürknopf beidseitig glass door handle double sided	1/1
8298MS36	RAL9005 Schwarz glänzend RAL9005 Gloss black			

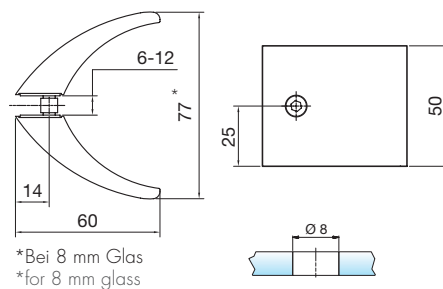

\*Bei 8 mm Glas  
\*for 8 mm glass

**Black  
EDITION**

Art.-Nr. Art.-no.	Oberfläche Finish	Glasdicke Glass thickness	Artikelbezeichnung Article name	VE/Stück Pu/pieces
8297MSPVD35-50	Schwarz matt Matt black	6-12 mm	Glastürgriff beidseitig glass door handle double sided	1/1
8297MSPVD36-50	Schwarz glänzend Gloss black			
8297MS35-50	RAL9005 Schwarz matt RAL9005 Matt black			
8297MS36-50	RAL9005 Schwarz glänzend RAL9005 Gloss black			



\*series Flamea+ suited for saunas

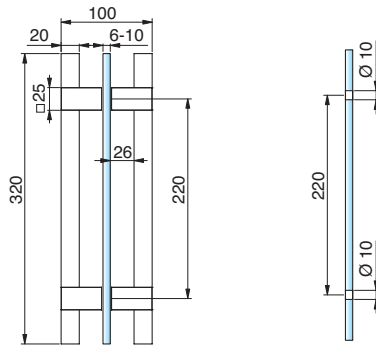

**Black  
EDITION**

Art.-Nr. Art.-no.	Oberfläche Finish	Glasdicke Glass thickness	Artikelbezeichnung Article name	VE/Stück Pu/pieces
8373MSPVD35-HEM	Schwarz matt Matt black	6-10 mm	Glastürgriff für Sauna-Anwendungen glass door handle for Sauna	1/1
8373MSPVD36-HEM	Schwarz glänzend Gloss black			

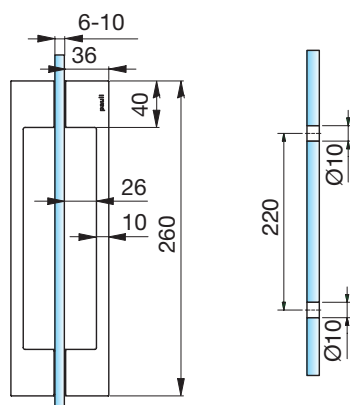

**Black  
EDITION**

Art.-Nr. Art.-no.	Oberfläche Finish	Glasdicke Glass thickness	Artikelbezeichnung Article name	VE/Stück Pu/pieces
8277ZNPVD35-A	Schwarz matt Matt black	6-10 mm	Glastürgriff beidseitig ohne Logoeindruck glass door handle double sided without logo	1/1
8277ZNPVD36-A	Schwarz glänzend Gloss black			
8277ZN35-A	RAL9005 Schwarz matt RAL9005 Matt black			
8277ZN36-A	RAL9005 Schwarz glänzend RAL9005 Gloss black			

U-Profil  
U-profile

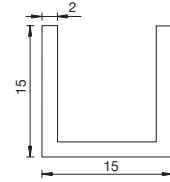

Art.-Nr. Article no.	Oberfläche Finish	Plattendicke plate thickness	Artikelbezeichnung Article name	VE/Stück Pu/pieces
5015E6C35-5M	Aluminium schwarz eloxiert Aluminium black anodized	≤ 10 mm	U-Profil, 15x15x5000x2 mm U-profile, 15x15x5.000x2 mm	1/1





## STABILISATIONSSYSTEME | SUPPORTING BARS

Rohrlängen beliebig kürzbar | tube length cuttable to size

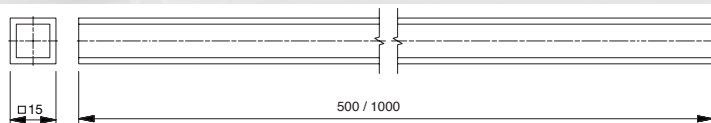
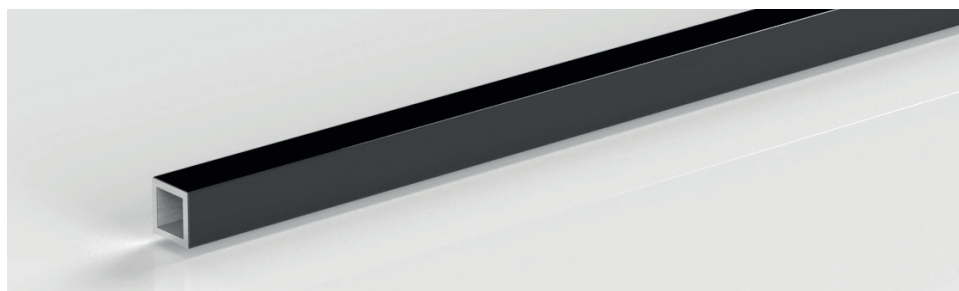

**Black  
EDITION**

Art.-Nr. Art.-no.	Oberfläche Finish	Länge length	Artikelbezeichnung Article name	VE/Stück Pu/pieces
8688-5MSPVD35-500	Schwarz matt Matt black	500 mm	Stabilisationsstange, Rohr supporting bar, tube	1/1
8688-5MSPVD36-1000	Schwarz matt Matt black	1000 mm		
8688-5MSPVD35-500	Schwarz glänzend Gloss black	500 mm		
8688-5MSPVD36-1000	Schwarz glänzend Gloss black	1000 mm		
8688-5AL35-500	RAL9005 Schwarz matt RAL9005 Matt black	500 mm		
8688-5AL36-1000	RAL9005 Schwarz matt RAL9005 Matt black	1000 mm		
8688-5AL35-500	RAL9005 Schwarz glänzend RAL9005 Gloss black	500 mm		
8688-5AL36-1000	RAL9005 Schwarz glänzend RAL9005 Gloss black	1000 mm		

für Rohr  $\square$  15 mm | for tube  $\square$  15 mm

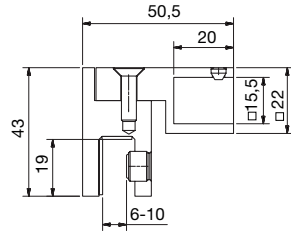

**Black  
EDITION**

Art.-Nr. Article no.	Oberfläche Finish	Glasdicke Glass thickness	Artikelbezeichnung Article name	VE/Stück Pu/pieces
8494MSPVD35-G	Schwarz matt Matt black	6-10 mm	Glasanschluss für Stabilisationsstange	1/1
8494MSPVD36-G	Schwarz glänzend Gloss black		glass adapter for supporting bar	
8494MS35-G	RAL9005 Schwarz matt RAL9005 Matt black			
8494MS36-G	RAL9005 Schwarz glänzend RAL9005 Gloss black			

für Rohr  $\square$  15 mm | for tube  $\square$  15 mm

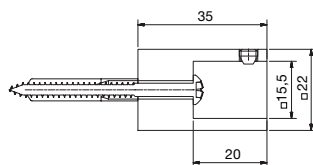
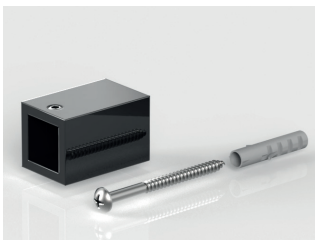

**Black  
EDITION**

Art.-Nr. Article no.	Oberfläche Finish	Artikelbezeichnung Article name	VE/Stück Pu/pieces
8494MSPVD35-W	Schwarz matt Matt black	Wandanschluss 90° für Stabilisationsstange	1/1
8494MSPVD36-W	Schwarz glänzend Gloss black	wall adapter 90° for supporting bar	
8494MS35-W	RAL9005 Schwarz matt RAL9005 Matt black		
8494MS36-W	RAL9005 Schwarz glänzend RAL9005 Gloss black		

für Rohr  $\square$  15 mm | for tube  $\square$  15 mm

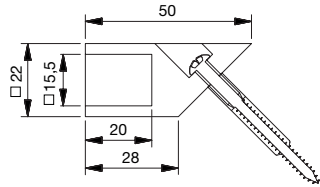

**Black  
EDITION**

Art.-Nr. Article no.	Oberfläche Finish	Artikelbezeichnung Article name	VE/Stück Pu/pieces
8496MSPVD35-W45	Schwarz matt Matt black	Wandanschluss 45° für Stabilisationsstange wall adapter 45° for supporting bar	1/1
8496MSPVD36-W45	Schwarz glänzend Gloss black		
8496MS35-W45	RAL9005 Schwarz matt RAL9005 Matt black		
8496MS36-W45	RAL9005 Schwarz glänzend RAL9005 Gloss black		

für Rohr  $\square$  15 mm | for tube  $\square$  15 mm

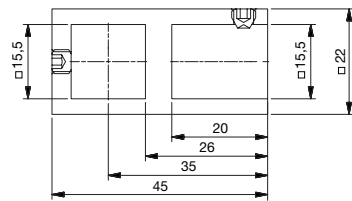

**Black  
EDITION**

Art.-Nr. Article no.	Oberfläche Finish	Artikelbezeichnung Article name	VE/Stück Pu/pieces
8497MSPVD35-T	Schwarz matt Matt black	T-Stück-Verbinder für Stabilisationsstange T-adapter for supporting bar	1/1
8497MSPVD36-T	Schwarz glänzend Gloss black		
8497MS35-T	RAL9005 Schwarz matt RAL9005 Matt black		
8497MS36-T	RAL9005 Schwarz glänzend RAL9005 Gloss black		





# Dichtprofile mit geringem Glaseinstand in schwarz Seal profiles with a reduced glass insertion in black

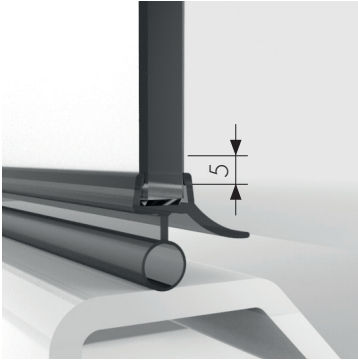

Art.-Nr. | Art.-No.  
8863KU0-8K-2010  
transparent | natural colour opaque  
8863KU3-8K-2010  
schwarz | black

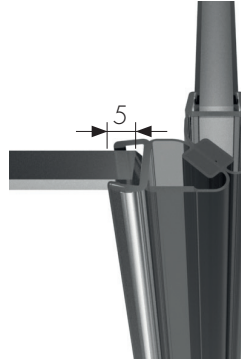

Art.-Nr. | Art.-No.  
8851KU0-8K-2500  
transparent | natural colour opaque  
8851KU3-8K-2500  
schwarz | black

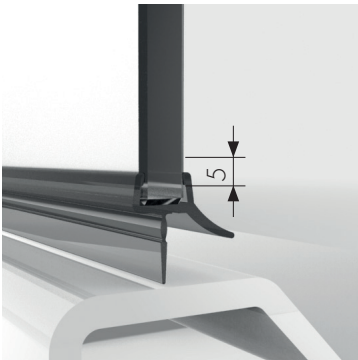

Art.-Nr. | Art.-No.  
8864KU0-8K-2010  
transparent | natural colour opaque  
8864KU3-8K-2010  
schwarz | black

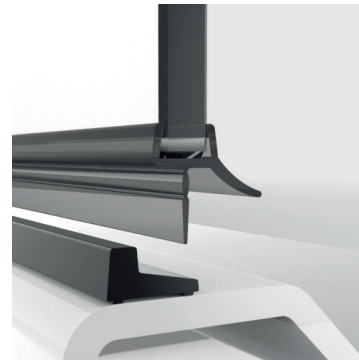

Art.-Nr. | Art.-No.  
8864KU0-8K-2010  
transparent | natural colour opaque  
8864KU3-8K-2010  
schwarz | black  
  
mit Schwallenschutz | with Splas guard  
8590AL35-1400

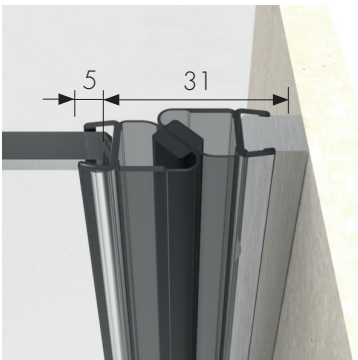

Art.-Nr. | Art.-No.  
8852KU0-8K-2500  
transparent | natural colour opaque  
8852KU3-8K-2500  
schwarz | black



Art.-Nr. | Art.-No.  
8852KU0-8K-2500  
transparent | natural colour opaque  
8852KU3-8K-2500  
schwarz | black  
  
Version – Glas-Glas  
Version – glass-glass

Schwallschutzprofile  
Splash guards

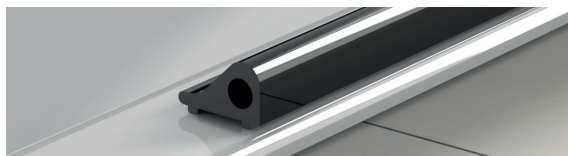

Black  
EDITION

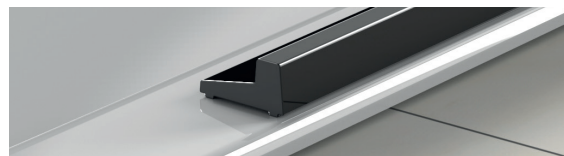

Black  
EDITION

Art.-Nr.   Art.-no.	Artikelbezeichnung   Article name
8535AL35-1400	Schwallschutzprofil in einer Länge von 1400 mm
8535AL36-1400	splash guard with a length of 1860 mm

Art.-Nr.   Art.-no.	Artikelbezeichnung   Article name
8590AL35-1400	Schwallschutzprofil in eckiger Version, Länge 1400
8590AL36-1400	splash protection profile square cut length 1400

Dichtprofile für den unteren Wannanschluss  
For sealing profiles for shower door/tray

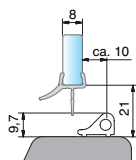

Art.-Nr.   Art.-no.	Artikelbezeichnung   Article name
8864KU0-8K-2010	für 8 mm Glas in Verbindung mit Schwallschutzprofil (Art.-Nr. 8535E6EV5)
8864KU3-8K-2010	for 8 mm glass in combination with splash guard (Art. no. 8535E6EV5)

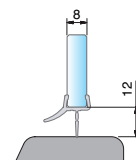

Art.-Nr.   Art.-no.	Artikelbezeichnung   Article name
8864KU0-8K-2010	für 8 mm Glas
8864KU3-8K-2010	for 8 mm glass

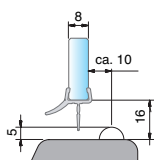

Art.-Nr.   Art.-no.	Artikelbezeichnung   Article name
8864KU0-8K-2010	für 8 mm Glas in Verbindung mit Acrylhalbrundstab (Art.-Nr. 8538KU5, Radius = 5 mm)
8864KU3-8K-2010	for 8 mm glass in combination with acrylic semi-circular rod (Art. no. 8538KU5, radius = 5 mm)

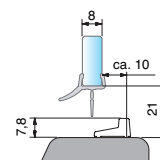

Art.-Nr.   Art.-no.	Artikelbezeichnung   Article name
8864KU0-8K-2010	für 8 mm Glas in Verbindung mit Schwallschutzprofil (Art.-Nr. 8590AL35-1400) eckige Version
8864KU3-8K-2010	for 8 mm glass in combination with splash guard (Art-No. 8590AL35-1400)

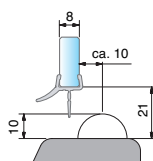

Art.-Nr.   Art.-no.	Artikelbezeichnung   Article name
8864KU0-8K-2010	für 8 mm Glas in Verbindung mit Acrylhalbrundstab (Art.-Nr. 8539KU5, Radius=10 mm)
8864KU3-8K-2010	for 8 mm glass in combination with acrylic semi-circular rod (Art. no. 8539KU5, radius = 10 mm)

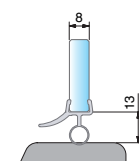

Art.-Nr.   Art.-no.	Artikelbezeichnung   Article name
8863KU0-8K-2010	für 8 mm Glas
8863KU3-8K-2010	for 8 mm glass

\*Art.-Nr./Material/Oberfläche: KU0 = Kunststoff naturfarbig-opak; KU3 = Kunststoff schwarz  
\*Article no. end: KU0 = plastic natural colour opaque; KU3 = plastic natural colour black

## Dichtprofile für Glas-Glas 90° Sealing profiles for glass-glass 90°

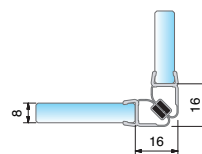
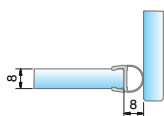

Art.-Nr.   Art.-no.	Artikelbezeichnung   Article name
8861KU0-8K-2500	für 8 mm Glas für ein ein- und beidseitig zu öffnendes Duschtürband   for 8 mm glass for an one sided opening shower hinge or pendelum shower hinge
8861KU3-8K-2500	

Art.-Nr.   Art.-no.	Artikelbezeichnung   Article name
8851KU0-8K-2500	für 8 mm Glas für ein einseitig nach außen hin öffnendes Duschtürband   for 8 mm glass for an one sided opening shower hinge or pendelum shower hinge
8851KU3-8K-2500	

## Dichtprofile für Glas-Glas 135° Sealing profiles for glass-glass 135°

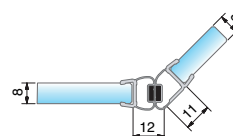
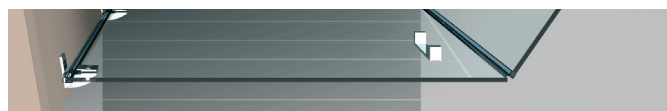
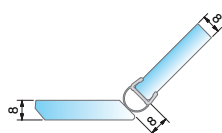

Art.-Nr.   Art.-no.	Artikelbezeichnung   Article name
8861KU0-8K-2500	für 8 mm Glas für ein beidseitig zu öffnendes Duschtürband   for 8 mm glass for an one sided opening shower hinge or pendelum shower hinge
8861KU3-8K-2500	

Art.-Nr.   Art.-no.	Artikelbezeichnung   Article name
8875KU0-8K-2500	für 8 mm Glas für ein ein- und beidseitig zu öffnendes Duschtürband   for 8 mm glass for an one sided opening shower hinge or pendelum shower hinge
8875KU3-8K-2500	

## Dichtprofile für Glas-Glas 180° Sealing profiles for glass-glass 180°

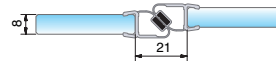
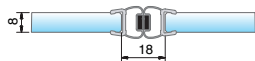

Art.-Nr.   Art.-no.	Artikelbezeichnung   Article name
8850KU0-8K-2500	für 8 mm Glas für ein beidseitig öffnendes Duschtürband
8850KU3-8K-2500	for 8 mm glass for an pendelum shower hinge

Art.-Nr.   Art.-no.	Artikelbezeichnung   Article name
8852KU0-8K-2500	für 8 mm Glas für ein einseitig öffnendes Duschtürband
8852KU3-8K-2500	for 8 mm glass for an one sided opening shower hinge

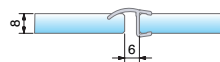
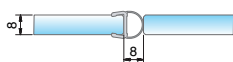

Art.-Nr.   Art.-no.	Artikelbezeichnung   Article name
8861KU0-8K-2500	für 8 mm Glas für ein beidseitig öffnendes Duschtürband
8861KU3-8K-2500	for 8 mm glass for an pendelum shower hinge

Art.-Nr.   Art.-no.	Artikelbezeichnung   Article name
8857KU0-8K-2500	für 8 mm Glas für ein einseitig öffnendes Duschtürband
8857KU3-8K-2500	for 8 mm glass for an one sided opening shower hinge





## Dichtprofile für den seitlichen Wandanschluss 90° Sealing profiles for door/wall 90°

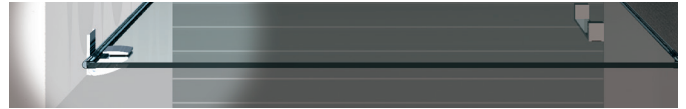
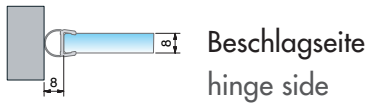

Art.-Nr.   Art.-no.	Artikelbezeichnung   Article name
8861KU0-8K-2500	für 8 mm Glas als Wanddichtung für ein beidseitig öffnendes Duschtürband
8861KU3-8K-2500	for 8 mm glass as a sealing to the wall for an pendulum shower hinge

## Dichtprofile für den seitlichen Wandanschluss 90° Sealing profiles for door/wall 90°



Art.-Nr.   Art.-no.	Artikelbezeichnung   Article name
8861KU0-8K-2500	für 8 mm Glas als Wanddichtung für ein beidseitig öffnendes Duschtürband
8861KU3-8K-2500	for 8 mm glass as a sealing to the wall for an pendulum shower hinge

## Dichtprofil an Trägerprofil für Türanschlag Sealing profile for carrier profile for door stop

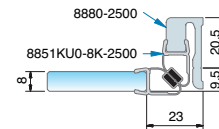
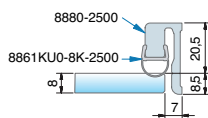

Art.-Nr.   Art.-no.	Artikelbezeichnung   Article name
8861KU0-8K-2500	für 8 mm Glas Trägerprofil mit Türanschlag for 8 mm glass carrier profile for door stop
8861KU3-8K-2500	

Art.-Nr.   Art.-no.	Artikelbezeichnung   Article name
8851KU0-8K-2500	für 8 mm Glas Trägerprofil mit Türanschlag for 8 mm glass carrier profile for door stop
8851KU3-8K-2500	

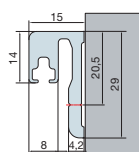

Art.-Nr.   Art.-no.	Artikelbezeichnung   Article name
8880_*2010	Länge = 2010 mm, Oberflächen siehe Art.-Nr.Endung
8880_*2500	length = 2010 mm, Finished see Article-no.-end Länge = 2500 mm, Oberflächen siehe Art.-Nr.-Endung length = 2500 mm, Finished see Article-no.-end

\*Art.-Nr.-Material/Oberfläche: E6/EV1 = Aluminium spezialgebeizt naturfarbig eloxiert; E6/EV5 = Aluminium spezialgebeizt glanzeloxiert; E1/23 = Aluminium geschliffen silberfarbig eloxiert (Edelstahleffekt); KU0 = Kunststoff naturfarbig-opak; KU3 = Kunststoff naturfarbig-opak

\*Art.-No.-Material/Oberfläche: E6/EV1 = aluminium special etched anodised natural colour; E6/EV5 = aluminium special etched anodised bright chrome finish; E0/14 = aluminium white powder coated, RAL 9016; KU0 = plastic natural colour opaque; KU3 = plastic natural colour black

\*Art.-Nr.-Material/Oberfläche: KU0 = Kunststoff naturfarbig-opak; KU3 = Kunststoff schwarz  
\*Article no. end: KU0 = plastic natural colour opaque; KU3 = plastic natural colour black

Trägerprofil für Dichtprofil  
Carrier profile for sealing

Bohrungsabstände  
Bore gaps

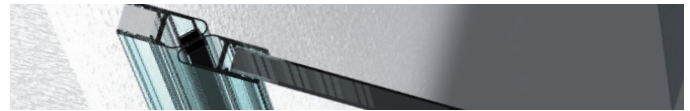
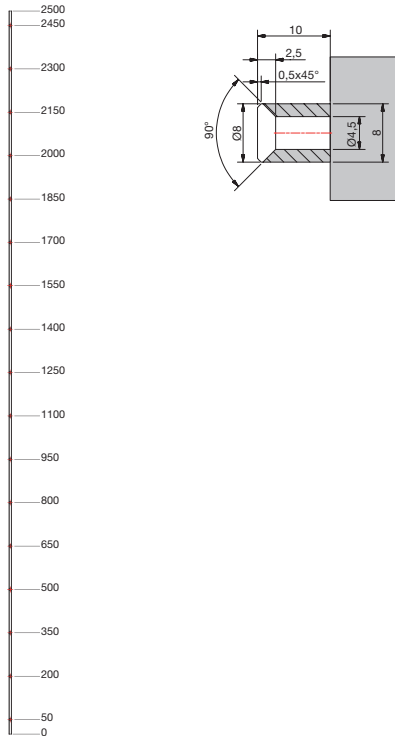

Anwendungen Trägerprofil  
Applications profile

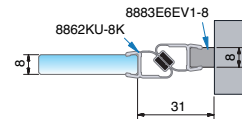

Art.-Nr.   Art.-no.	Artikelbezeichnung   Article name
8852KU0-8K-2500	für 8 mm Glas, mit Dichtprofil und Trägerprofil 8883E6EV1-8
8852KU3-8K-2500	for 8 mm glass with sealing profile 8852KU0-8K-2500 / 8852KU3-8K-2500 and carrier section 8883E6EV1-8

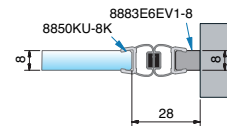

Art.-Nr.   Art.-no.	Artikelbezeichnung   Article name
8850KU0-8K-2500	für 8 mm Glas, mit Dichtprofil und Trägerprofil 8883E6EV1-8
8850KU3-8K-2500	for 8 mm glass with sealing profile 8850KU0-8K-2500 / 8850KU3-8K-2500 and carrier section 8883E6EV1-8

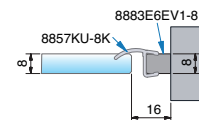

Art.-Nr.   Art.-no.	Artikelbezeichnung   Article name
8857KU0-8K-2500	für 8 mm Glas, mit Dichtprofil und Trägerprofil 8883E6EV1-8
8857KU3-8K-2500	for 8 mm glass with sealing profile 8857KU0-8K-2500 / 8857KU3-8K-2500 and carrier section 8883E6EV1-8